

**DIGITAL-INNEN-SCHNELLMESSTASTER**  
*DIGITAL CALIPER GAUGE FOR INSIDE MEASUREMENT*



209.281/209.282



209.283/209.284



209.281/209.282

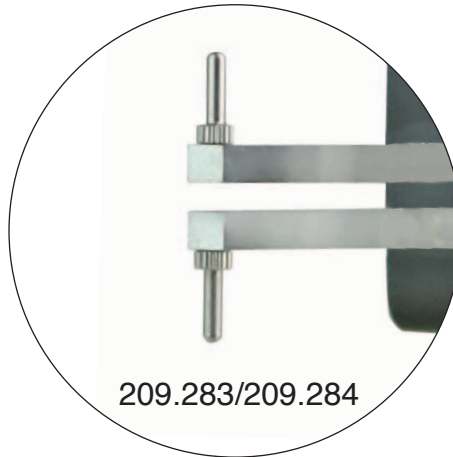

209.283/209.284

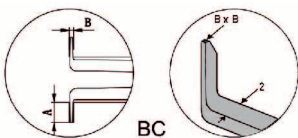

BC

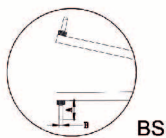

BS

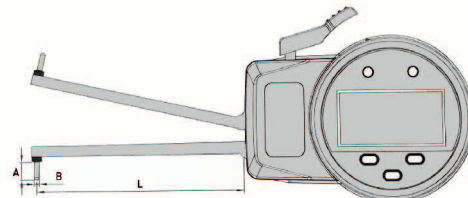
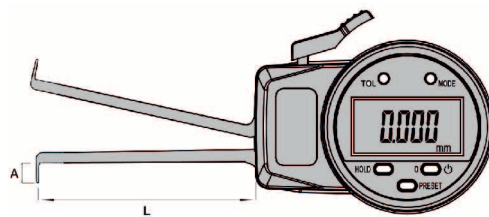

- zum schnellen Messen von Bohrungen, Nuten usw.
  - mit Digital-Messuhr IP 65
    - Anzeige mit Laufbalken
    - mm/inch-, 0/Off, Preset-, Tol- und „Mode“-Taste
  - mit wiederladbarer Lithiumbatterie
  - im Behältnis/Kasten
- 
- *for measuring bores, internal groove etc.*
  - *with digital dial indicator IP 65*
    - *display with scroll bar*
    - *mm/inch, o/off, preset, tol and mode button*
  - *built in rechargeable lithium battery*
  - *in case/box*

Art.-Nr. <i>Item no.</i>	Messbereich <i>Range mm</i>	Ableseung <i>Reading mm</i>	Genauigkeit <i>Accuracy mm</i>	A <i>mm</i>	B <i>mm</i>	L <i>mm</i>
209.281	6 - 15	0,002	± 0,05	2,3	0,8	35
209.282	10 - 30	0,005	± 0,05	5,2	1,2	85
209.283	30 - 50	0,005	± 0,05	7,2	∅ 2,0	85
209.284	50 - 100	0,01	± 0,05	11,7	∅ 2,0	236

**DIGITAL-AUSSEN-SCHNELLMESSTASTER**

*DIGITAL CALIPER GAUGE FOR OUTSIDE MEASUREMENT*



209.291



209.293

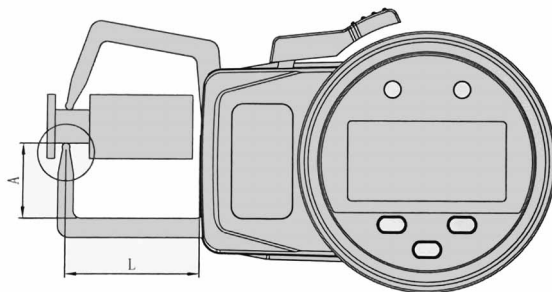
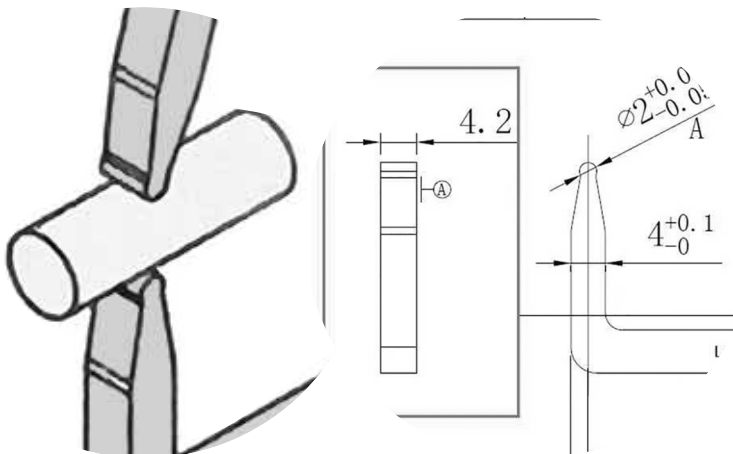

- zum schnellen Messen von Außen-Nuten usw.
- mit gerundeter Messflächen
- mit Digital-Messuhr IP 65
  - Anzeige mit Laufbalken
  - mm/inch-, 0/Off, Preset-, Tol- und „Mode“-Taste
- mit wiedeladbarer Lithiumbatterie
- im Behältnis/Kasten
  
- *for measuring bores, outside groove etc.*
- *with round measuring face*
- *with digital dial indicator IP 65*
  - *display with scroll bar*
  - *mm/inch, o/off, preset, tol and mode button*
- *built in rechargeable lithium battery*
- *in case/box*

Art.-Nr. <i>Item no.</i>	Messbereich <i>Range mm</i>	Ableseung <i>Reading mm</i>	Genauigkeit <i>Accuracy mm</i>	A <i>mm</i>	R <i>mm</i>	L <i>mm</i>
209.291	0 - 10	0,002	± 0,03	19,5	1	35
209.292	0 - 20	0,005	± 0,03	25,0	1	85
209.293	0 - 30	0,01	± 0,05	30,0	1	116
209.294	0 - 50	0,01	± 0,05	34,0	1	236